

POLO X IP65 SLIM Bulkhead

Product Codes: **POLX13, POLX13E, POLX13/MS, POLX13E/MS, POLX13/MSCF & POLX13E/MSCF**

Safety Warning



- The installation should be carried out by a qualified electrician in compliance with the current edition of the IEE Wiring Regulations.
- Prior to installation, carry out the necessary risk assessment considering the people who could be at risk, the level of risk and the precautions required to control the risk
- Ensure that the circuit supply is isolated either by the circuit supply fuse being removed or the applicable circuit breaker being turned off before installation or any maintenance.
- Check the total load on the circuit ensuring the luminaire does not exceed the rating of the circuit cable, fuse or circuit breaker.
- Long-term use and voltage fluctuations can reduce the life span of the fitting.
- If the fitting incorporates control gear, ensure careful sizing to avoid instances of nuisance tripping of the protective device used in the installation.
- Follow the provided installation instructions, using the fixings supplied or recommended.
- Keep out of reach of children.



Specification

Box Contents -
1 x Polo-X Fitting
1 x Bag of Fixings

Dimensions:	Ø: 314 x D: 81mm
Material:	Polycarbonate body & diffuser
Working Temperature:	Standard: -20°C - 40°C Emergency: 0°C - 40°C
Included:	Bag of fixings

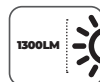
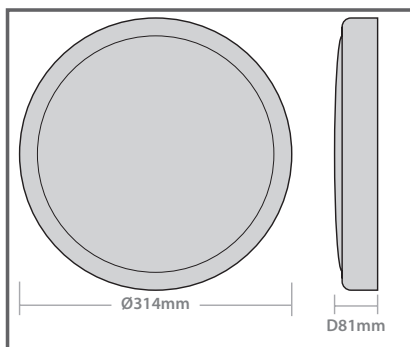

*Batteries 1 year guarantee

MAXIMUM FITTINGS PER CIRCUIT

Automatic Circuit Breaker Type:	B6	B10	B13	B16	B20	C10	C13	C16	C20
Rated Current:	6A	10A	13A	16A	20A	10A	13A	16A	20A
Cable (mm):	1.5	1.5	1.5	1.5	2.5	1.5	1.5	1.5	2.5
POLX13	40	70	90	120	150	70	90	120	150
POLX13E	35	65	85	110	140	65	85	110	140

Installation Instructions

Note: This is a Class II Luminaire - No Earth required

1. Isolate the mains supply before commencing with the installation.
2. Remove the diffuser and trim from the base by rotating 45° anti-clockwise to unlatch, then pull away.
3. Loosen, but do not remove, the 3 x gear tray retaining screws, rotate the gear tray to align the screw heads with the large aperture of the keyhole slots and remove the gear tray away from the base.

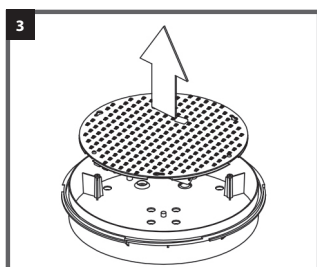
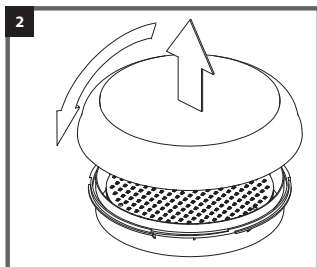

4. A cable entry point is provided via a blind grommet, which should be pierced to pass a cable through. For exterior or wet indoor areas, replace the grommet with a suitable IP rated cable gland [not supplied].
5.
 - A. Feed the mains cable through the grommet / gland fitted in previous steps.
 - B. Hold the fitting up to the ceiling / wall in the desired position and mark hole fixing centres.
 - C. Drill fixing holes.
 - D. Insert rawl plugs.
 - E. Fix in position with fixings supplied.
6. Ensure the luminaire has a switched live supply to "L" [switched live]. Route the mains supply cable to the terminal block on the gear tray and terminate, ensuring correct polarity is observed. Ensure all conductors are fully sleeved and insulated.

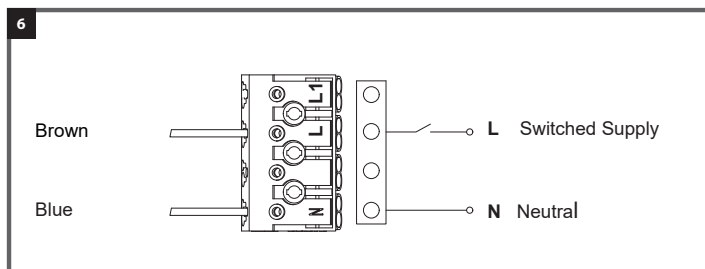

7. Refit the gear tray and secure by retightening the screws.
 8. Refit the diffuser and trim by placing over the base and rotate clockwise until it locks into position.
- Restore the mains power supply, switch on and test for satisfactory operation.

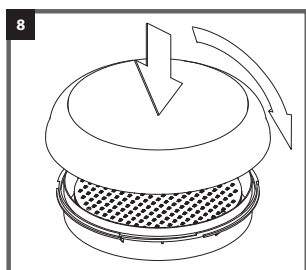

Emergency Version Instructions

1. Follow instructions 1-5 on the previous page.
2. The luminaire requires a secondary unswitched live supply as well as a switched supply. Connect the unswitched supply to the terminal marked L1. Connect the switched supply to the terminal marked L. The "unswitched" supply must be taken from the same phase as the "switched" supply and must be wired to the same MCB so that upon test, it is isolated at the same time as the switched supply.

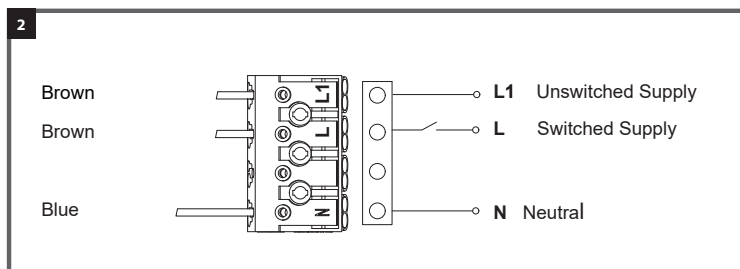

3. Route the cable to the terminal block and terminate, ensuring correct location is observed.
4. When the power supply is reconnected, check the green LED illuminates. This indicates the batteries are charging.
5. The batteries should be charged for at least 24 hours before carrying out a full discharge test, to check batteries are charging correctly and 3 hour emergency duration is achieved.

Note: For non-maintained operation, only an unswitched supply to terminal L1 is required.
For switched maintained, follow the instructions in no.2 above.
For unswitched maintained operation, connect cables as in 2 above but also link L & L1.

Instructions for Microwave Sensor Set Up

The Microwave Sensor allows the Bulkhead to detect when an occupant enters or leaves an area, turning the luminaire on or off accordingly.

- The sensor should be positioned so that the occupants of the area fall inside the detection patterns shown in the diagram below.

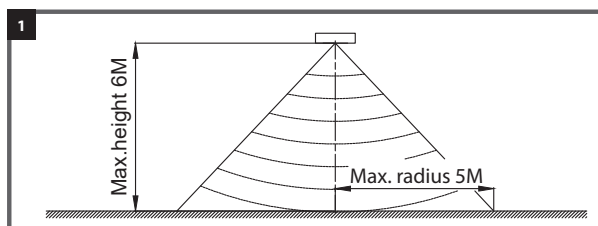

- The diagram is based on a maximum ceiling mounting height of 6m. Note that the lower the sensor is installed, the smaller the detection range will be e.g. at a ceiling height of 2.8m the detection diameter is approximately 4.7m.
- The distances quoted are approximate and may vary depending on the surroundings.
- Do not site within 1m of forced air heating or ventilation.
- Do not fix to a vibrating surface.
- Sensitivity** can be adjusted by selecting the required combination on dip switches 1 & 2 for different applications.

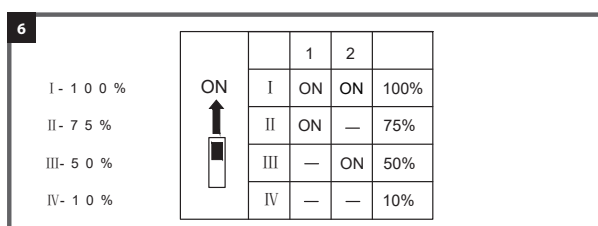

- Hold time** refers to the time period that the light remains on if no more movement is detected. Set using dip switches 3 & 4.

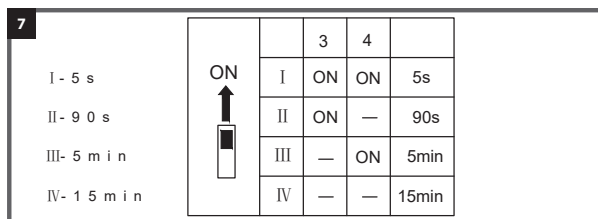

- Different **daylight thresholds** can be pre-set using dip switches 5 & 6. Light will always turn on upon movement if daylight sensor is disabled.

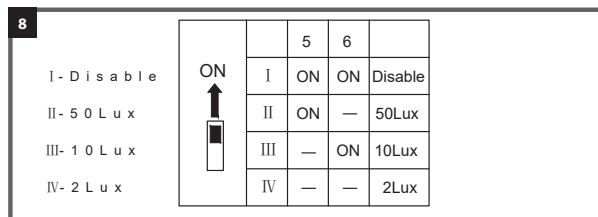

Instructions for Microwave Sensor Corridor Function Set Up

The Microwave Sensor allows the Bulkhead to detect when an occupant enters or leaves an area, turning the luminaire on or off accordingly. The corridor function allows the bulkhead to dim down to a pre-set level for a period of time (pre-set) after occupants have left the area, before turning off completely.

- Follow instructions 1-5 above but using diagrams below.

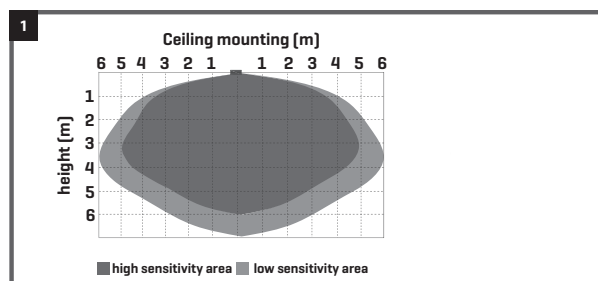

2. Sensitivity can be adjusted by selecting the required combination on dip switch 1 for different applications.

2

I - 100%
II - 50%



	1	
I	●	100%
II	○	50%

3. Hold time refers to the time period that the light remains on if no more movement is detected. Set using dip switches 2 & 3.

3

I - 5s
II - 90s
III - 3min
IV - 10min



	2	3	
I	●	●	5s
II	●	○	90s
III	○	●	3min
IV	○	○	10min

4. Different daylight thresholds can be pre-set using dip switches 4 & 5. Light will always turn on upon movement if daylight sensor is disabled.

4

I - Disable
II - 50Lux
III - 10Lux
IV - 2Lux



	4	5	
I	●	●	Disable
II	●	○	50Lux
III	○	●	10Lux
IV	○	○	2Lux

5. Stand by time refers to the time period that the light remains at a low level before it is completely turned off if the area continues not to be occupied. This can be set using dip switches 6 & 7.

6. Stand by dimming level allows the light to be dimmed to different levels after hold time. This can be set using dip switch 8.

5

I - 0s
II - 10s
III - 10min
IV - +∞



	6	7	
I	●	●	0s
II	●	○	10s
III	○	●	10min
IV	○	○	+∞

6

I - 10%
II - 30%



	8	
I	●	10%
II	○	30%

Guarantee

This product is guaranteed for a period of 3* years from the date of purchase (* batteries 1 year). The guarantee is invalid in the case of improper use, tampering, removal of the Q.C. date label, installation in an improper working environment or installation not according to the current edition of the I.E.E. Wiring Regulations (BS7671). The guarantee is also invalidated if the luminaire has been insulation tested. Should this product fail during the guarantee period it will be replaced free of charge, subject to correct installation and return of the faulty unit. We do not accept responsibility for any installation costs associated with the replacement of this product. Your statutory rights are not affected. We reserve the right to alter specifications without prior notice.

Maintenance

- This fitting will require routine cleaning if used in adverse (dust, paint, welding, oils etc) environments. Do not use solvents, aggressive detergents or abrasives.
- The light source & driver in this luminaire can be quickly and easily replaced at end of life. This should be carried out by a competent person. Contact Red Arrow for details of replacements.

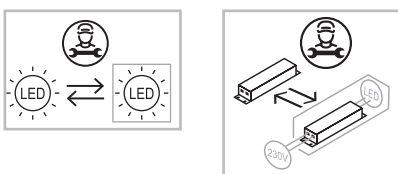

- When this fitting comes to the end of its life or you choose to replace it, please do not dispose of it with your normal waste. Please recycle where the facilities exist, check with your local authority for suitable options.

INS/COMMERCIAL/0007/POLX13/V4