

# INSTALLATION INSTRUCTIONS

## Artemis M/NM Exit Sign (/ST Version with Self Test)

Product Codes: **ART/30 & ART/30/ST & ART/30/D & ART/30/ST/D**

### Safety Warning



- The installation should be carried out by a qualified electrician in compliance with the current edition of the IEE Wiring Regulations.
- Prior to installation, carry out the necessary risk assessment considering the people who could be at risk, the level of risk and the precautions required to control the risk
- Ensure that the circuit supply is isolated either by the circuit supply fuse being removed or the applicable circuit breaker being turned off before installation or any maintenance.
- Check the total load on the circuit ensuring the luminaire does not exceed the rating of the circuit cable, fuse or circuit breaker.
- Long-term use and voltage fluctuations can reduce the life span of the fitting.
- If the fitting incorporates control gear, ensure careful sizing to avoid instances of nuisance tripping of the protective device used in the installation.
- Follow the provided installation instructions, using the fixings supplied or recommended.
- Keep out of reach of children.



### Specification

#### Box Contents -

1 x Exit Sign Box c/w Up Arrow Legend. /ST Version with Self Test Functionality.

<b>Dimensions:</b>	ART/30 & ART/30/ST ART/30/D & ART/30/ST/D	H: 186 x L: 330 x D: 30mm H: 186 x L: 330 x D: 47mm
<b>Material:</b>	Polycarbonate	
<b>Colour Temperature:</b>	6500K	
<b>CRI:</b>	Ra>80	
<b>LED Lifetime:</b>	L70B50 36,000 Hrs	
<b>IP Rating:</b>	IP20	
<b>Working Temperature:</b>	0°C to 45°C	
<b>Guarantee:</b>	5 Years	

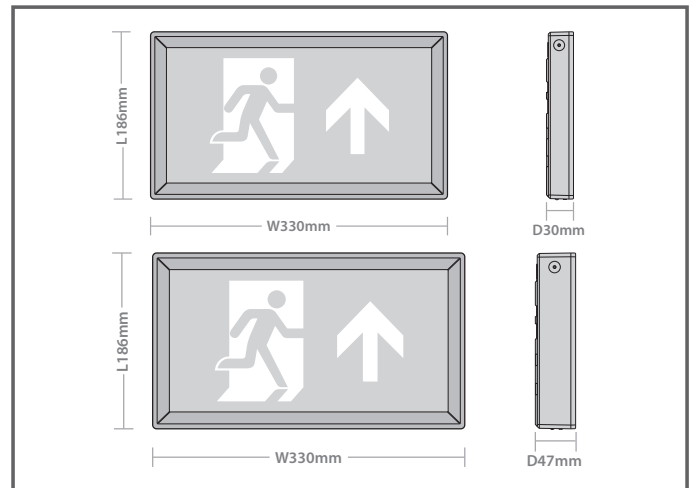

(Self Test Version Only)

### Installation Instructions

- Isolate the mains supply before carrying out any installation or maintenance work.
- Remove the front cover from the fitting. Gently insert a flat blade screwdriver into the slots on the base and lever up to release the tabs. Lift off the cover, removing the 2 pin plug from the PCB, if connected.
- Drill out the preferred fixing points and cable entry. The body has a central BESA box fixing plus pre-formed keyhole slots as shown. Additional drill out cable entries are located on either side of the fitting.
- Fix the body to the wall in the desired location and using preferred method, using the fixings supplied and passing the supply cable through the cable entry point. Ensure that a suitable grommet or similar is used at the cable entry point.

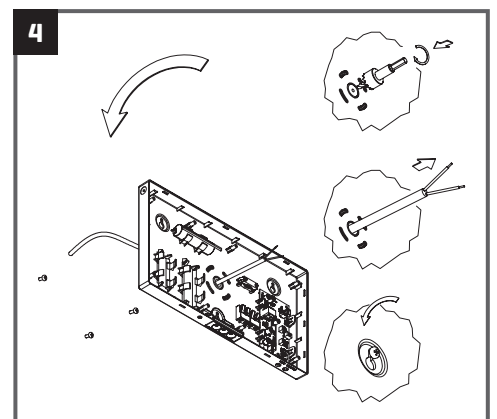
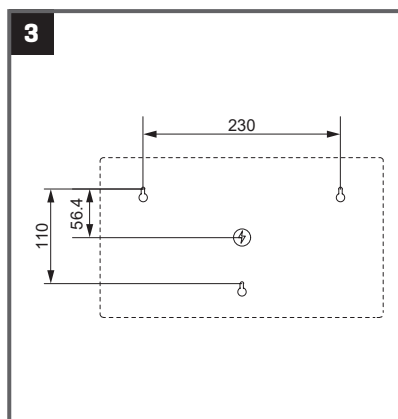
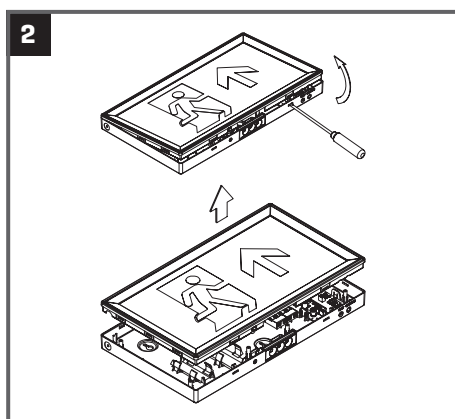

5. Connect the supply cable to the terminal block. An unswitched supply must be connected to the Live (L) and Neutral (N) terminals. The fitting can be operated as follows:
  - A. For Maintained operation, connect supply as above, leaving the link wire pre-fitted between the Live (L) and Switched Live (LS) terminals in place.
  - B. For Non-Maintained operation, connect supply as above and remove the link wire between the Live (L) and Switched Live (LS) terminals.
  - C. For Switched Maintained operation, connect supply as above plus connect a switched live supply to the terminal marked LS. Remove the link wire between the Live (L) and Switched Live (LS) terminals.
6. Plug the cable from the battery into the white 3 pin connector on the PCB.
7. The emergency duration is set as default to 3 hour operation. It can be set to 1 hour duration by adjusting both the dip switches on the PCB to the 'on' position.

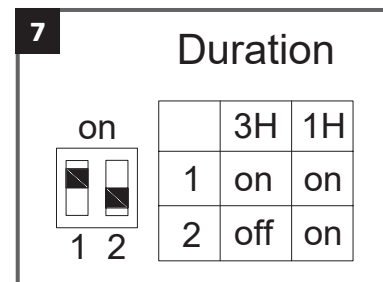
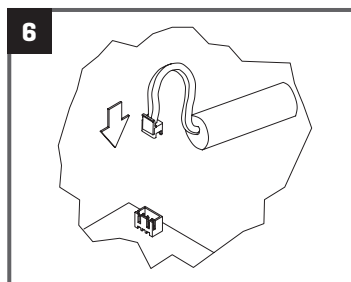
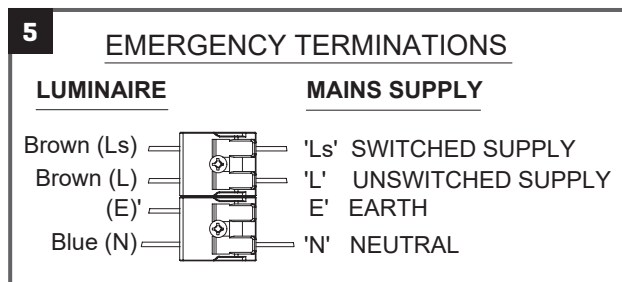

8. Replace the front cover/legend, reconnecting the 2 pin connector to the PCB first. Engage the tabs at the top first then snap the bottom into place. Secure the cover with the small screw provided into the location on bottom edge.
9. Adjust the threshold illumination lens on the bottom edge as required.

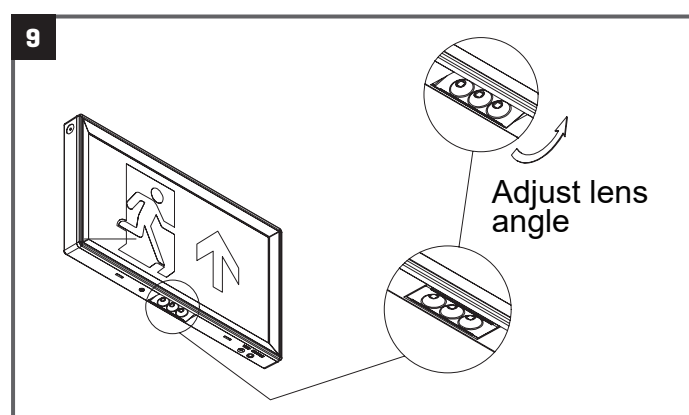
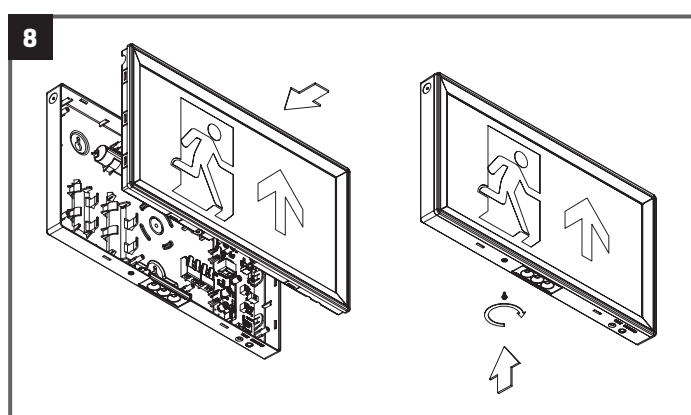

10. Restore the mains supply and check that the green LED indicator is illuminated and that the luminaire operates correctly.
11. Leave the power connected for 24 hours to fully charge the batteries and then carry out an emergency commissioning test.
12. This fitting is supplied with an Up Arrow legend as standard. Down, Left and Right arrow legends are available to order separately. To replace, apply pressure and push the legend diagonally from the bottom right, to release the tab and then gently release the remainder and remove.
13. To fit the new legend, reverse the removal procedure, locating the left hand tab first then gently easing the legend into the slot until correctly seated on all sides.

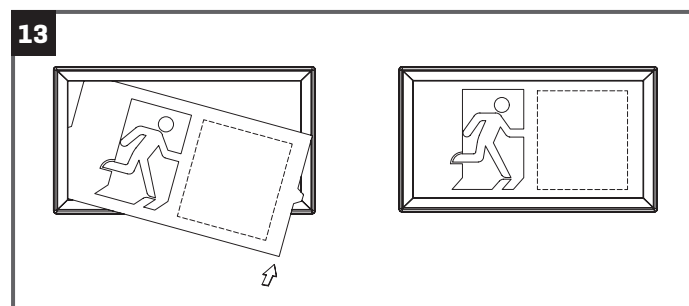
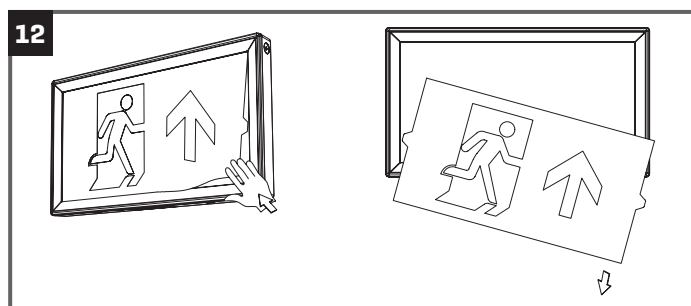

## Self Test Version Only

ART/30/ST features stand alone automatic self test operation.

After the power supply has been connected and the batteries have charged for 24 hours, the fitting will perform the following tests automatically, which meet and exceed legal requirements. The status during and after the tests is provided by a bi-colour LED Indicator

### Initial Duration Test

This is carried out 24 hours after the fitting has been connected to the power supply, provided the supply is uninterrupted and the batteries have been charging for this period. This test lasts for the rated duration of the luminaire, 3 hours.

### Function Test

This test is carried out every month for 3 minutes, checking the functionality of the emergency module, batteries and LED module.

### Duration Test

This is carried out every year (every 300 to 365 days). The test lasts for the rated duration of the luminaire, 3 hours.

### NOTES:









If a mains supply failure occurs during a scheduled test or in the preceding 24 hours, the test will be postponed for 3 days.

The timing function is accurate to within  $\pm 75s$  per week. Timing is retained during periods of mains failure or interruption for up to 7 days.

Tests will not be performed when the mains supply is disconnected

## System Status Indication

The system status, including testing and any faults is provided by a bi-colour LED indicator on the fitting. Status is provided as follows:

LED Colour	Status	Flash Rate On Time	Flash Rate Off Time	Details	
Green		Permanent On	-	-	Normal operation - Battery is charging
		Slow Flash	1s	1s	3 hr duration test in progress
		Fast Flash	0.2s	0.2s	3 min function test in progress
		Flash 3 Times only	0.5s	0.5s	Self test timer reset
Red		Permanent On	-	-	Battery charge failure
		Slow Flash	1s	1s	LED module failure
		Fast Flash	0.2s	0.2s	Battery duration failure
Off		Off	-	-	System in emergency mode. Mains disconnected from battery, or mains failure

### Test Button

The fitting has a test button, which can be used to perform the following functions:

Press for < 2s – Simulate emergency mode

Press for 3-5s – Manually start a duration test. Abort test by pressing the button for 1-2s

Press for 5-8s – Manually start a 60s function test. Abort test by pressing the button for 1-2s

Press for > 10s – Timer reset

## Battery Replacement

1. Isolate the mains supply and remove the front cover.
2. Unplug the battery lead from the circuit board.
3. Write the current date on the new battery pack.
4. Fit the new battery pack.
5. Plug the battery back into the circuit board.
6. Replace the front cover, restore the power and allow to charge for 24 hours. Then carry out a full duration test.
7. Self Test Version Only – After restoring the power press the test button for >10s to reset the timer and allow to charge for 24 hours.
8. Self Test Version Only – The fitting will carry out an automatic duration test after 24 hours. Check the indicator status after the test for normal operation

## Guarantee

This product is guaranteed for a period of 5 years from the date of purchase. The guarantee is invalid in the case of improper use, tampering, removal of the Q.C. date label, installation in an improper working environment or installation not according to the current edition of the I.E.E. Wiring Regulations (BS7671). The guarantee is also invalidated if the luminaire has been insulation tested. Should this product fail during the guarantee period it will be replaced free of charge, subject to correct installation and return of the faulty unit. We do not accept responsibility for any installation costs associated with the replacement of this product. Your statutory rights are not affected. We reserve the right to alter specifications without prior notice.

## Maintenance

- This fitting will require routine cleaning if used in adverse (dust, paint, welding, oils etc) environments. Do not use solvents, aggressive detergents or abrasives.
- The light source & driver in this luminaire can be quickly and easily replaced at end of life. This should be carried out by a competent person. Contact Red Arrow for details of replacements.

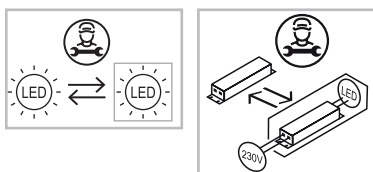

- When this fitting comes to the end of its life or you choose to replace it, please do not dispose of it with your normal waste. Please recycle where the facilities exist, check with your local authority for suitable options.

INS\_EMERGENCY\_0020\_ART\_V2

# INSTALLATION INSTRUCTIONS

## Emergency Testing Sheet

### Testing (Emergency Versions)

The emergency lighting must be tested and inspected regularly in accordance with local codes of practice.

NOTE: For safety reasons tests should be carried out preceeding time of low risk, to allow for battery recharge.

The minimum recommended test schedule is as follows:

Commissioning - After installation, allow 24 hours to ensure full battery charge, and then interrupt the supply; check after 3 hours that the light is still illuminated.

1. Daily - Check that the charge indicator LED is working.
2. Monthly - Interrupt the power supply for a period sufficient to ensure each light is illuminated. At the end of the test, restore the supply and check the indicator is illuminated.
3. Annually - Interrupt the supply as in 2, but for the full rated duration. Ensure the light is illuminated at the end of the rated duration. Restore the supply and check the indicator is illuminated.
4. Record the date and result of each test, attending to any maintenance required in the event of a test failure.

**Luminaire Location** .....

**Date Installed** .....

**Date Commissioned** .....

Month	Test	Year 1			Year 2			Year 3		
		Signed	Result / Action	Date	Signed	Result / Action	Date	Signed	Result / Action	Date
1	Functional									
2	Functional									
3	Functional									
4	Functional									
5	Functional									
6	Functional									
7	Functional									
8	Functional									
9	Functional									
10	Functional									
11	Functional									
12	Full Duration									